

1. zadatak		ŠALICA	30 bodova
	Primjer:	Rješenje	Bodovi
1.	cs salica 200 280 30	Slika 1.1	6
2.	cs salica 150 150 10	Slika 1.2	6
3.	cs salica 80 270 0	Slika 1.3	6
4.	cs salica 200 250 32	Slika 1.4	6
5.	cs salica 200 280 5	Slika 1.5	6
UKUPNO:			30

Napomene:

- Bodovi se dodjeljuju ako je lik ispravno nacrtan.
- Pozicija i rotacija lika na ekranu nije bitna.

2. zadatak		MIKI	40 bodova	
	Primjer:	Rješenje	Bodovi 1	Bodovi 2
1.	cs miki 100 60 20 180	Slika 2.1	4	8
2.	cs miki 80 30 15 225	Slika 2.2	4	8
3.	cs miki 50 20 10 120	Slika 2.3	4	8
4.	cs miki 110 20 25 60	Slika 2.4	4	8
5.	cs miki 70 20 10 90	Slika 2.5	4	8
UKUPNO:			40	

Napomene:

- Za svaki test-primjer, bodovi se dodjeljuju iz samo jedne bodovne grupe.
- Bodovi 1 se dodjeljuju ako su dobro nacrtani glava, oči i nos (šest kružnica!), a ostalo nije.
- Bodovi 2 se dodjeljuju ako je sve dobro nacrtano.
- Pozicija i rotacija mikija na ekranu nije bitna.

3. zadatak DRVORED 60 bodova

	Primjer:	Rješenje	Bodovi
1.	cs drvored 50 5 300 10 90	Slika 3.1	10
2.	cs drvored 90 10 250 10 100	Slika 3.2	10
3.	cs drvored 30 7 150 20 40	Slika 3.3	10
4.	cs drvored 45 12 220 30 80	Slika 3.4	10
5.	cs drvored 120 21 320 50 150	Slika 3.5	10
6.	cs drvored 130 15 250 30 40	Slika 3.6	10
UKUPNO:			60

Napomene:

- Bodovi se dodjeljuju ako je ispravno nacrtan drvored i nije se pojavila nikakva greška.
- Pozicija i rotacija na ekranu nije bitna.

4. zadatak POLICA 70 bodova

	Primjer:	Rješenje	Bodovi 1	Bodovi 2
1.	cs polica [[100 10] [80 20] [120 30]] 80 10	Slika 4.1	5	10
2.	cs polica [[100 20] [200 40]] 80 20	Slika 4.2	5	10
3.	cs polica [[50 20] [100 30] [25 9] [150 15] [80 60]] 200 20	Slika 4.3	5	10
4.	cs polica [] 200 50	Slika 4.4	5	10
5.	cs polica [[50 100] [100 50]] 200 100	Slika 4.5	5	10
6.	cs polica [[100 20] [80 20] [60 20]] 100 20	Slika 4.6	5	10
7.	cs polica [[50 20] [100 30] [40 40] [70 30]] 150 30	Slika 4.7	5	10
UKUPNO:			70	

Napomene:

- Bodovi se dodjeljuju samo iz jedne bodovne grupe.
- Bodovi 1 se dodjeljuju ako su nacrtane sve knjige ali nisu u pravom poretku (nisu sortirane po visini), ili se ne nalaze na lijevom kraju.
- Bodovi 2 se dodjeljuju ako je sve dobro nacrtano.
- Pozicija i rotacija na ekranu nije bitna.

1. zadatak – slike

ŠALICA

30 bodova

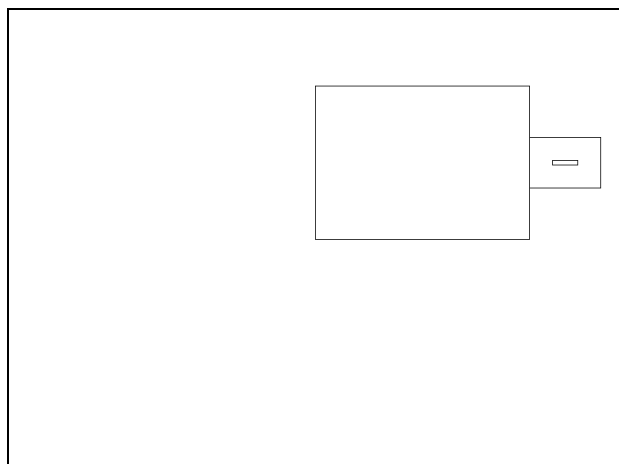

Slika 1.1

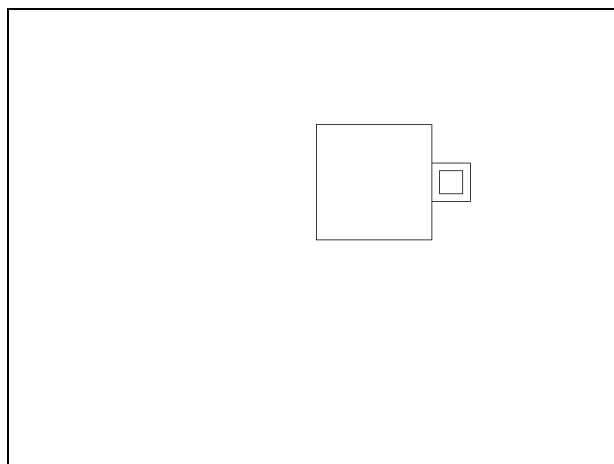

Slika 1.2

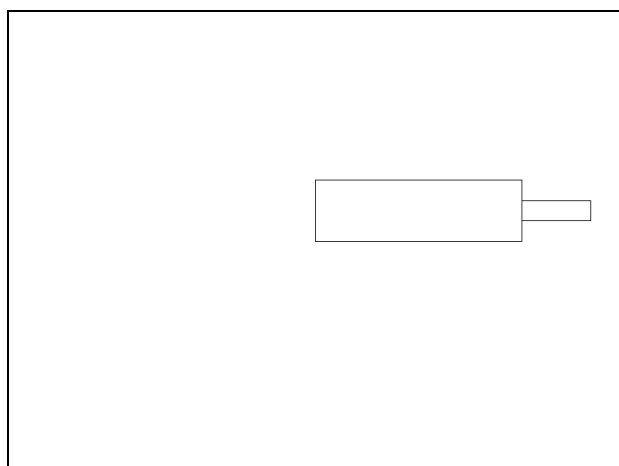

Slika 1.3

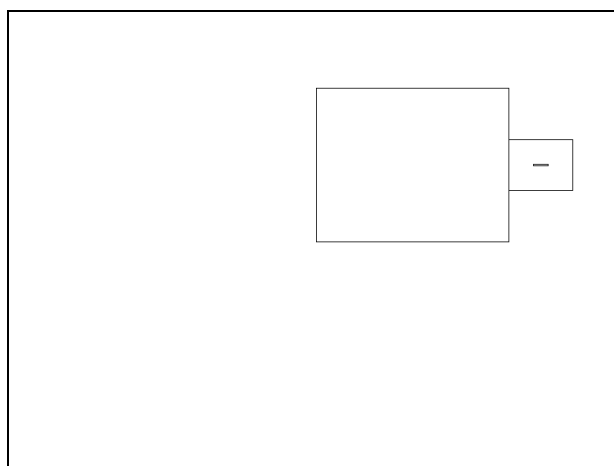

Slika 1.4

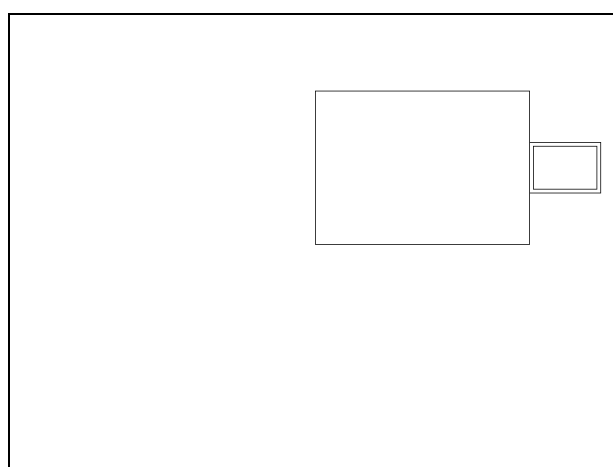

Slika 1.5

2. zadatak – slike

MIKI

40 bodova

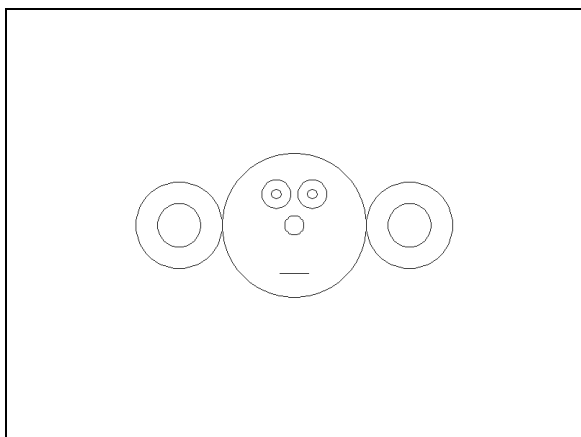

Slika 2.1

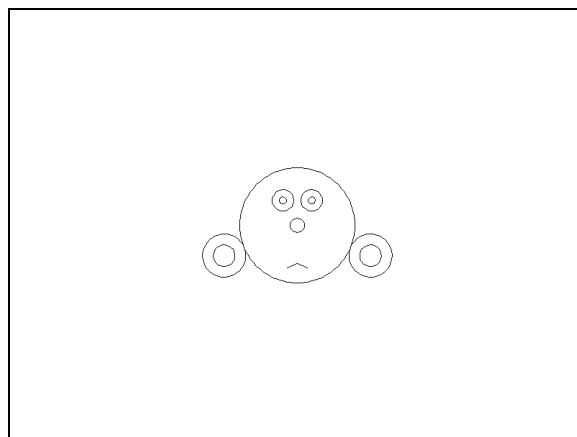

Slika 2.2

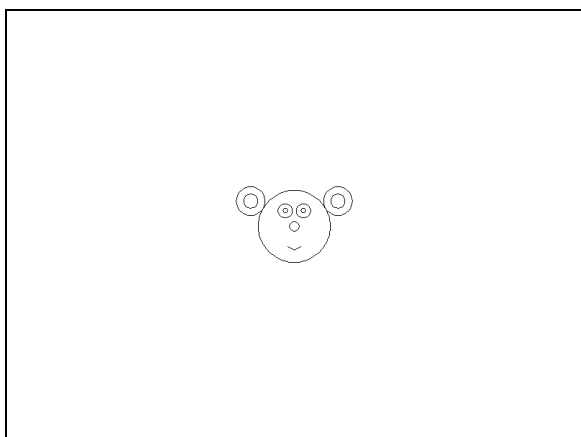

Slika 2.3

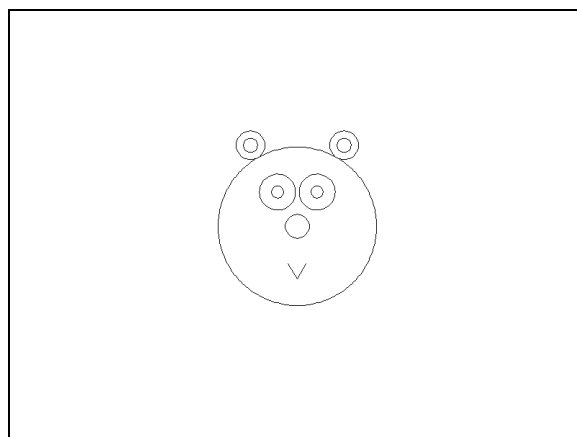

Slika 2.4

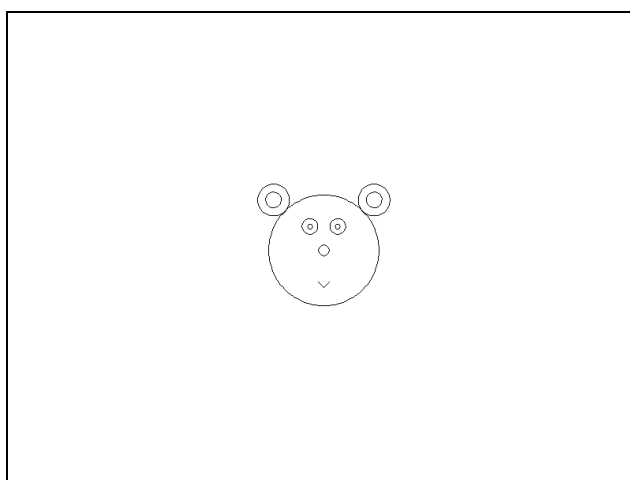

Slika 2.5

3. zadatak – slike

DRVORED

60 bodova

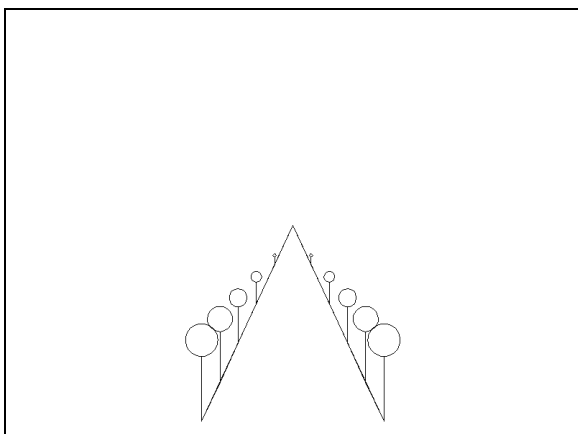

Slika 3.1

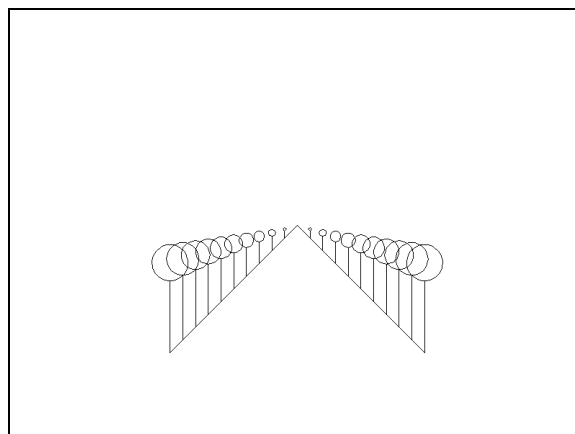

Slika 3.2

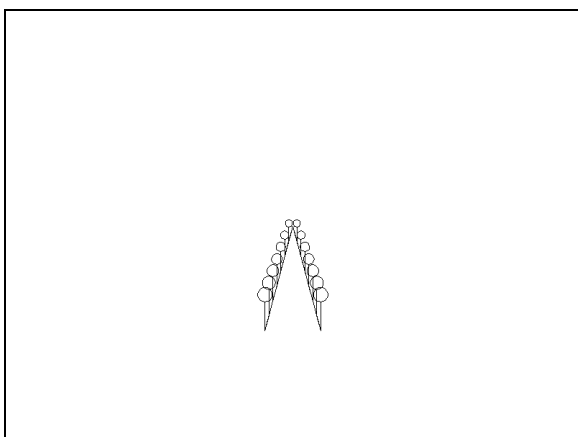

Slika 3.3

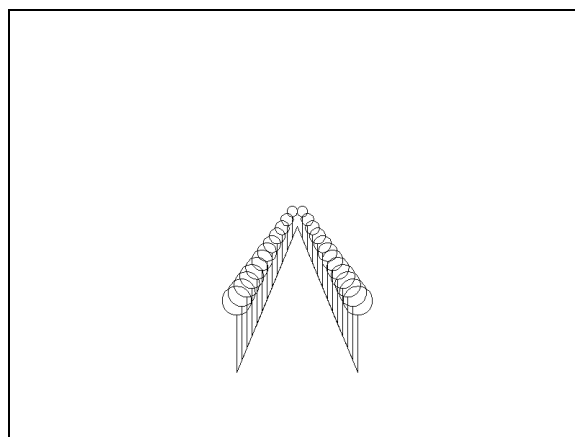

Slika 3.4

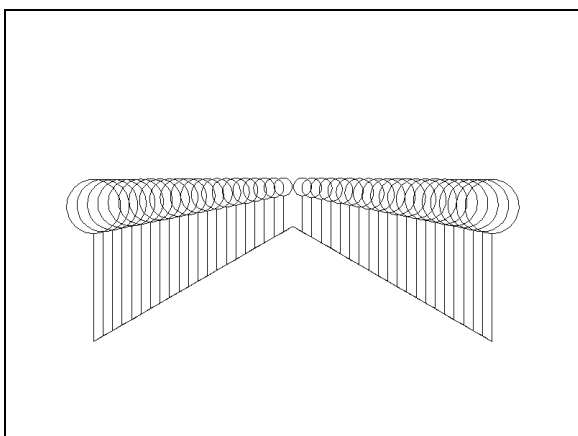

Slika 3.5

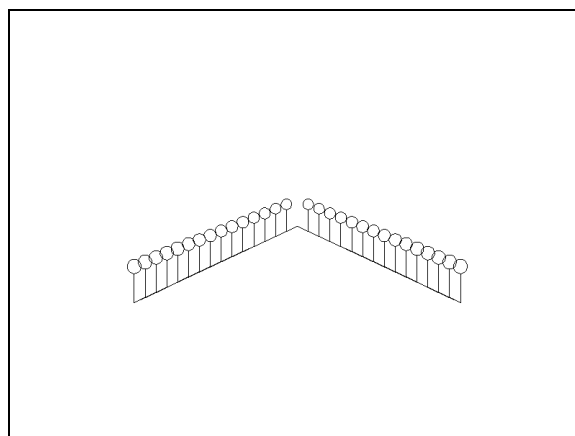

Slika 3.6

4. zadatak – slike

POLICA

70 bodova

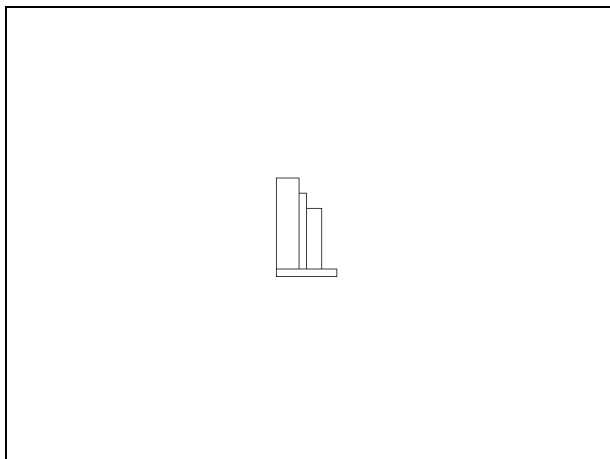

Slika 4.1

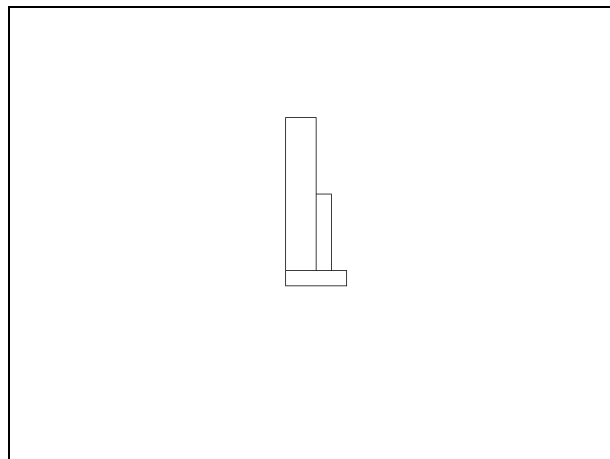

Slika 4.2

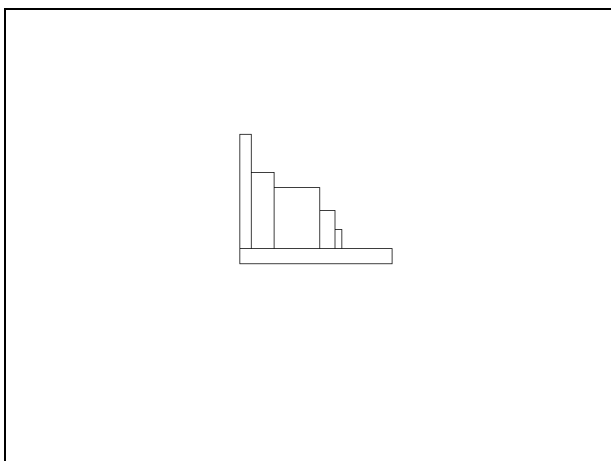

Slika 4.3

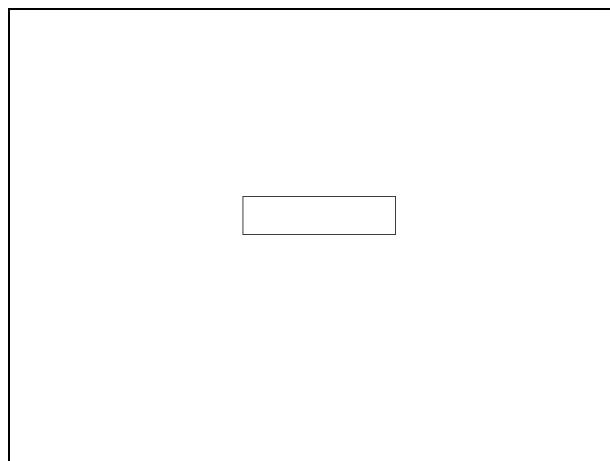

Slika 4.4

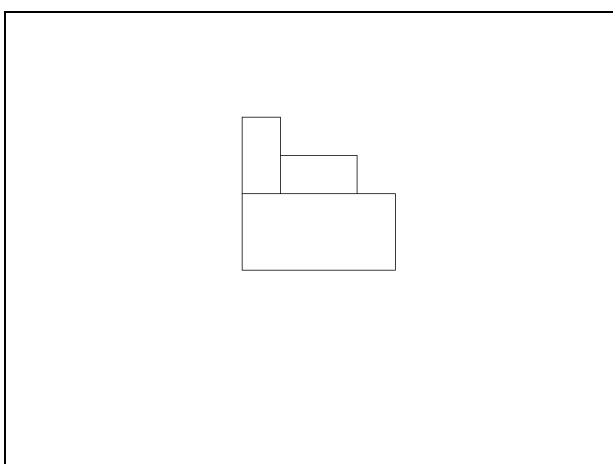

Slika 4.5

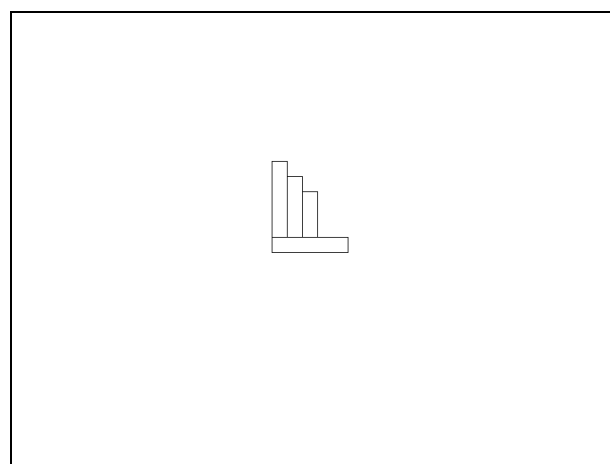

Slika 4.6

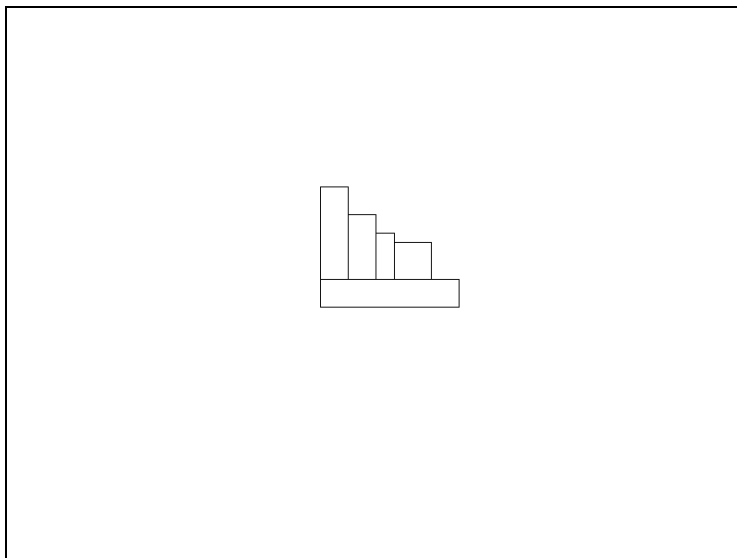

Slika 4.7